

---

# Michel Club

SOFAS

*Antonio Citterio*



## Description

Michel Club nasce come evoluzione del sistema Michel. L'orientamento verso una diversa tipologia tecnica formale che ne riproporziona il rapporto tra struttura e cuscinatura rende Michel Club una proposta di design più tradizionale seppur contemporaneo. I suoi 36 elementi componibili, 5 pouf oltre ai divani lineari consentono un'ampia gamma di configurazioni. Cuscini schienali confortevoli con supporto poggiatesta e cuscini complementari di varie dimensioni permettono di offrire sedute relax o da conversazione, all'insegna del comfort e dell'eleganza. Michel Club è disponibile in un'ampia gamma di tessuti e pelli della collezione B&B Italia. L'abbinamento di texture e colori differenti consente un'ulteriore personalizzazione del sistema di sedute.

---

## Technical information

### Telaio interno schienale e bracciolo:

tubolari e profilati d'acciaio

### Imbottitura telaio interno schienale e bracciolo:

schiuma di poliuretano flessibile a freddo Bayfit® (Bayer®), fibra di poliestere, fodera in fibra di poliestere

### Telaio interno sedile:

tubolari e profilati d'acciaio verniciato, pannello in multistrato di legno, poliuretano sagomato

### Imbottitura cuscino sedile:

poliuretano sagomato a densità differenziata, piuma sterilizzata, fodera in fibra di poliestere

### Cuscino schienale (C65C-C50C):

imbottitura : piuma + inserto poliuretano, tipologia : a fascia

### Cuscino schienale con rullo (C65CP-C50CP):

imbottitura : piuma + inserto poliuretano + fibra di poliestere, tipologia : a fascia + rullo

### Struttura di sostegno:

fusioni ed estrusi d'alluminio spazzolato lucido, verniciato nickel bronzato, verniciato peltro o verniciato cromato nero

### Puntali:

materiale termoplastico

### Rivestimento:

tessuto o pelle

# Technical drawings

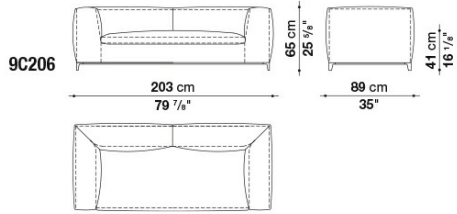

9C206

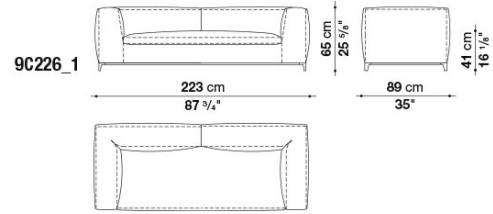

9C226\_1

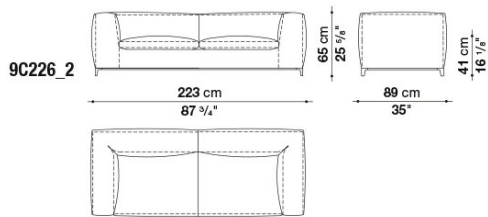

9C226\_2

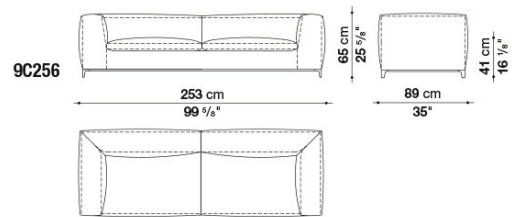

9C256

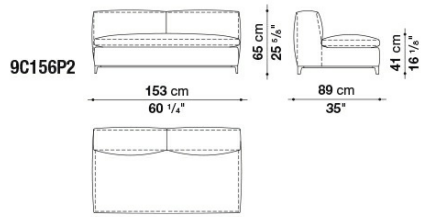

9C156P2

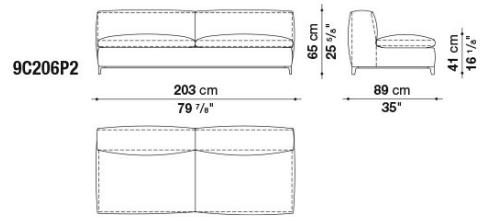

9C206P2

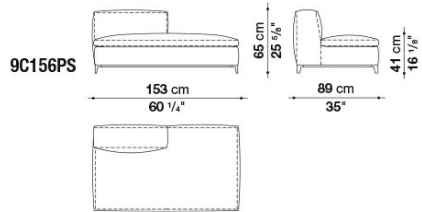

9C156PS

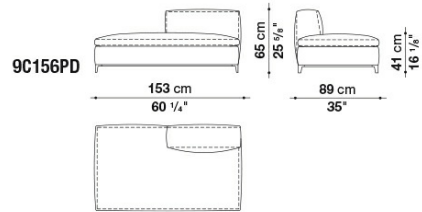

9C156PD

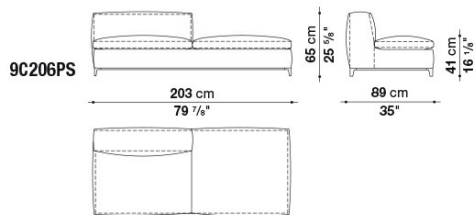

9C206PS

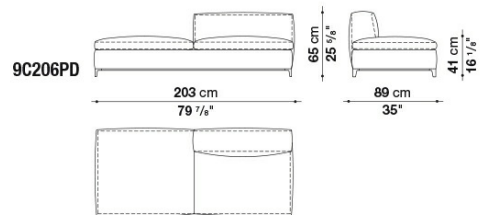

9C206PD

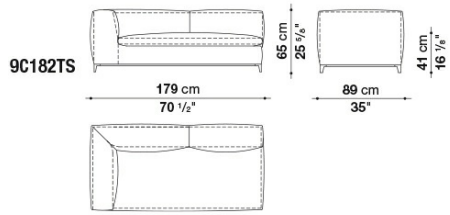

**9C182TS**

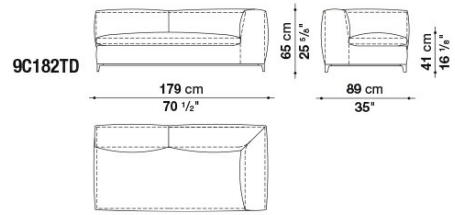

**9C182TD**

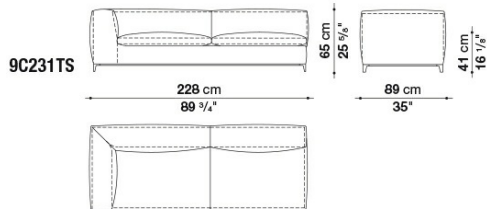

**9C231TS**

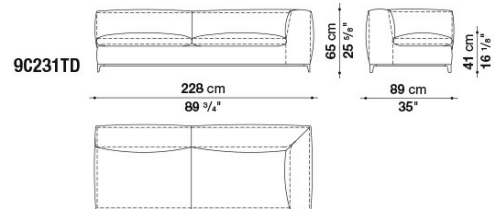

**9C231TD**

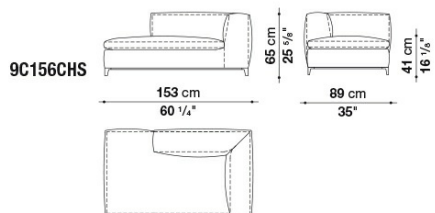

**9C156CHS**

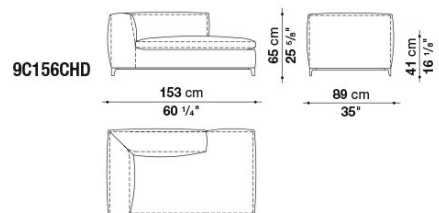

**9C156CHD**

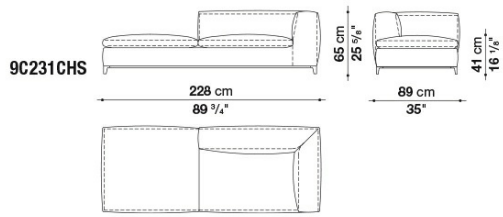

9C231CHS

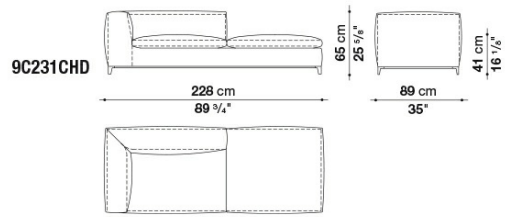

9C231CHD

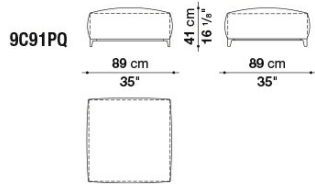

9C91PQ

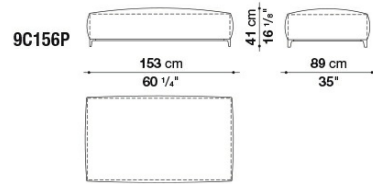

9C156P

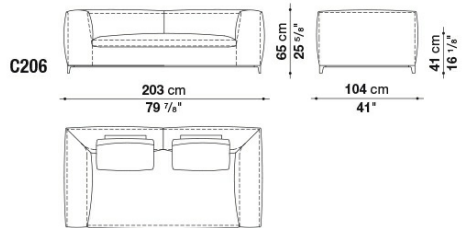

C206

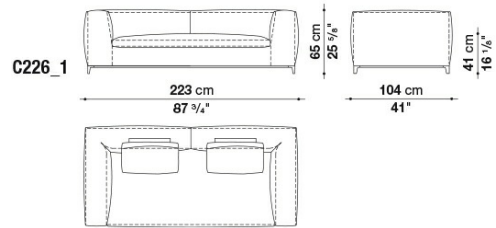

C226\_1

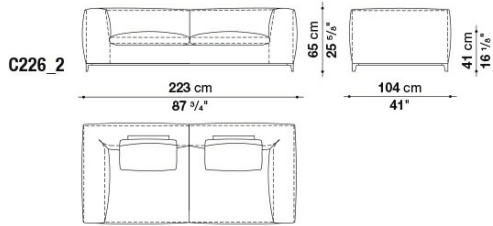

**C226\_2**

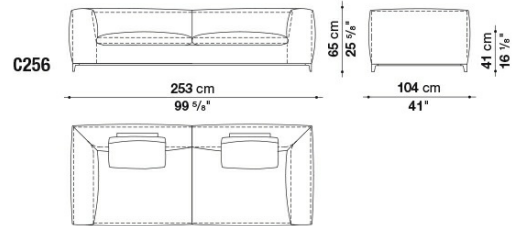

**C256**

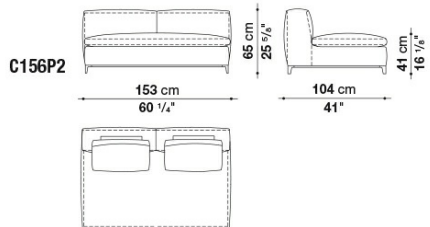

**C156P2**

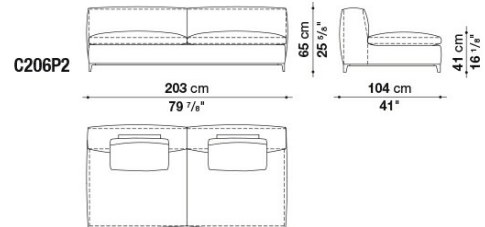

**C206P2**

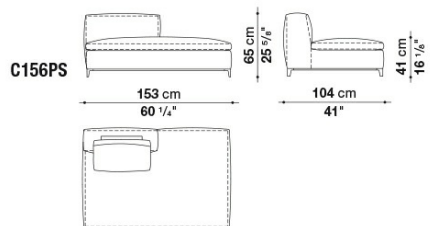

**C156PS**

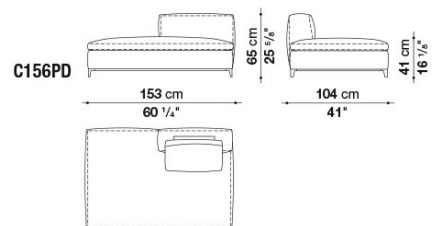

**C156PD**

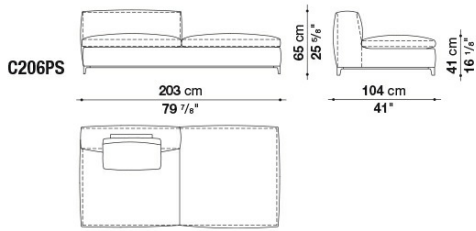

**C206PS**

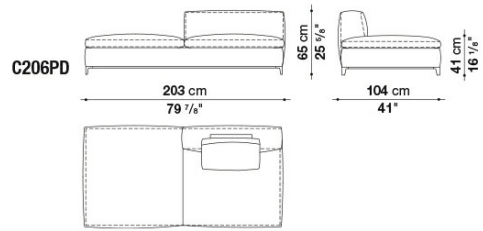

**C206PD**

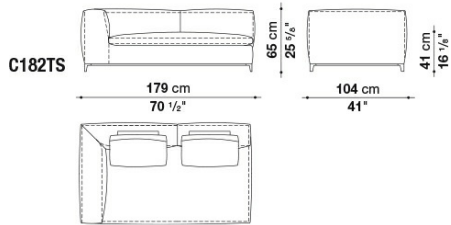

**C182TS**

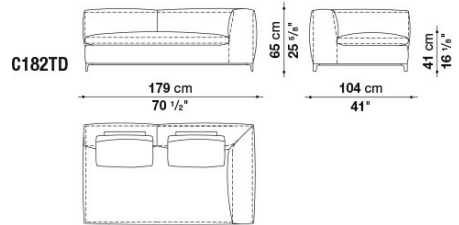

**C182TD**

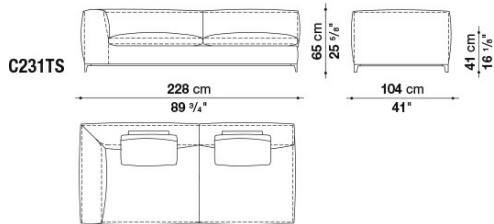

**C231TS**

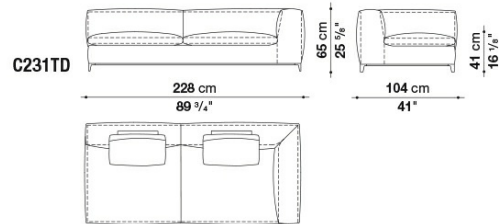

**C231TD**



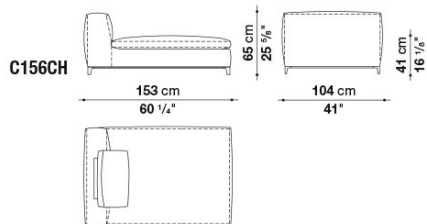

C156CH

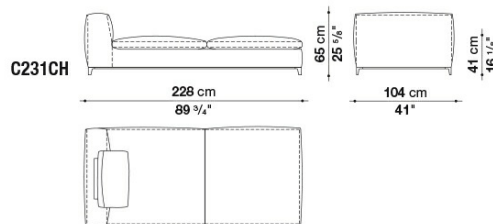

C231CH

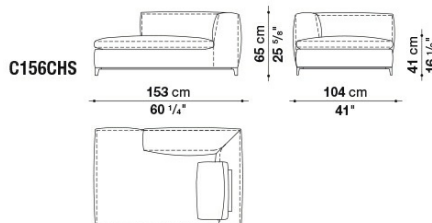

C156CHS

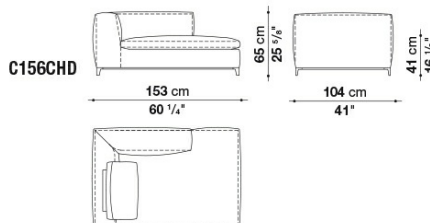

C156CHD

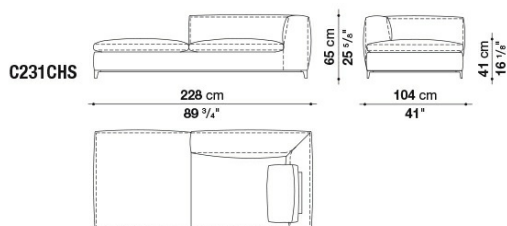

C231CHS

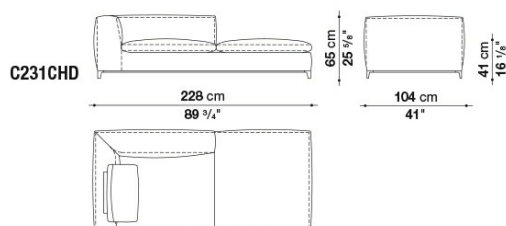

C231CHD

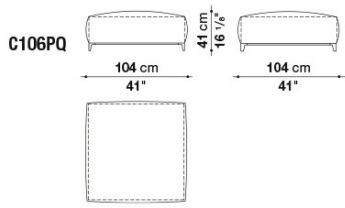

C106PQ

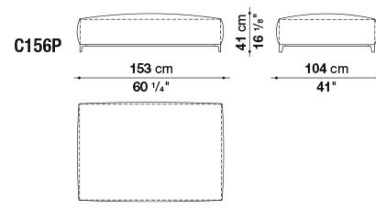

C156P

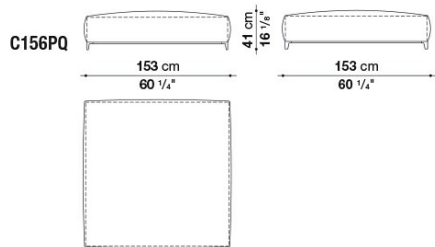

C156PQ

---

# Compositions

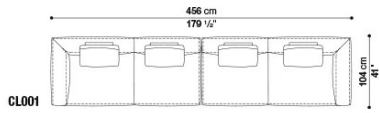

01

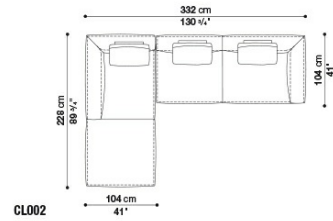

02

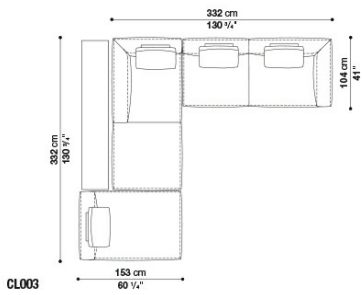

03

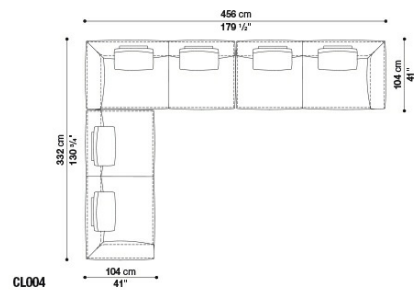

04

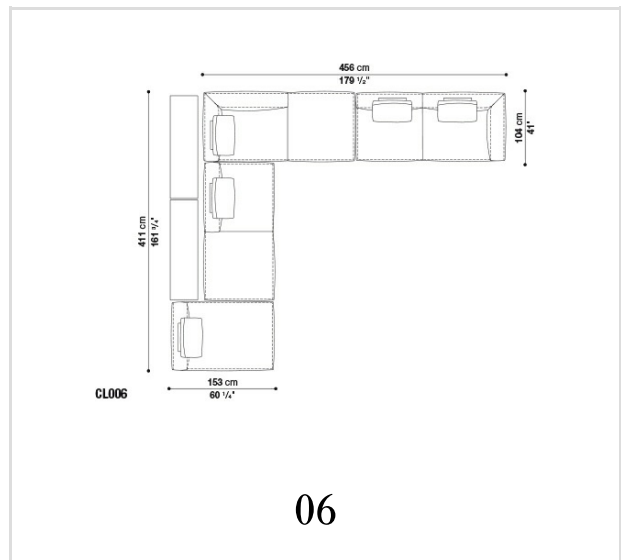
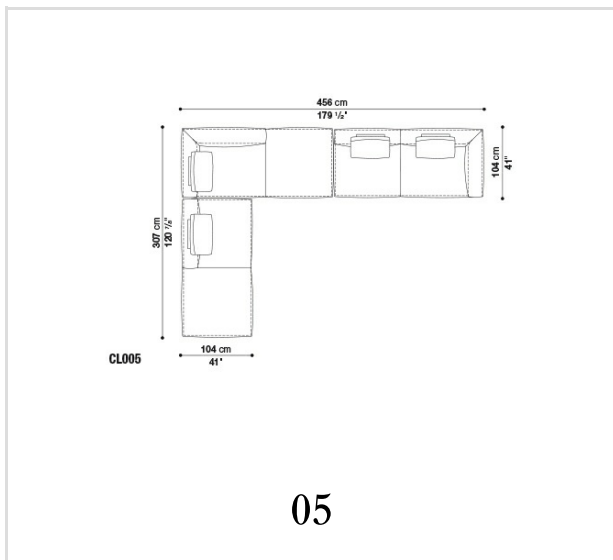

B&B Italia reserves the right to make technological and aesthetic improvements to its models, including changes to the sizes and materials, without notice. The technical drawings do not define the details of the product. The measurements shown are indicative and may undergo changes. In particular, the dimensions relevant to the padded parts are subject to usage tolerances over time caused by the normal adjustment of the padding. For the specific information, please contact the dealer closest to you.