

---

# Michel Effe

SOFAS

*Antonio Citterio*



## Description

Con Michel Effe, il sistema di sedute di Antonio Citterio viene aggiunto un capitolo importante a una storia iniziata con Michel, il primo componibile della serie. Michel Effe ricerca e trova una maggiore essenzialità rispetto ai suoi predecessori. Inalterate alcune caratteristiche, tra cui le due profondità, rivela un nuovo disegno grazie alla semplificazione della seduta che si sviluppa con un unico cuscino. Più secco, ma non meno confortevole, elimina tutto ciò che è superfluo.

---

## Technical information

### Telaio interno schienale e bracciolo:

tubolari e profilati d'acciaio

### Imbottitura telaio interno schienale e bracciolo:

schiuma di poliuretano flessibile a freddo Bayfit® (Bayer®), fibra di poliestere, fodera in fibra di poliestere

### Telaio interno sedile:

tubolari e profilati d'acciaio verniciato, pannello in multistrato di legno, poliuretano sagomato

### Imbottitura cuscino sedile:

poliuretano sagomato a densità differenziata, piuma sterilizzata, fodera in fibra di poliestere

### Cuscino schienale (MF65C-MF50C):

imbottitura : piuma + inserto poliuretano, tipologia : a fascia

### Cuscino schienale con rullo (MF65CP-MF50CP):

imbottitura : piuma + inserto poliuretano + fibra di poliestere, tipologia : a fascia + rullo

### Struttura di sostegno:

fusioni ed estrusi d'alluminio spazzolato lucido, verniciato nickel bronzato, verniciato peltro o verniciato cromato nero

### Puntali:

materiale termoplastico

### Rivestimento:

tessuto o pelle

# Technical drawings

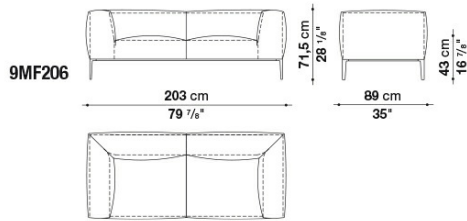

9MF206

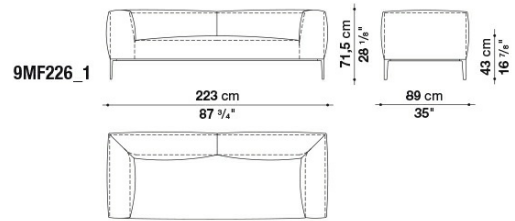

9MF226\_1

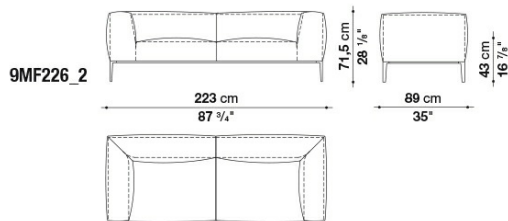

9MF226\_2

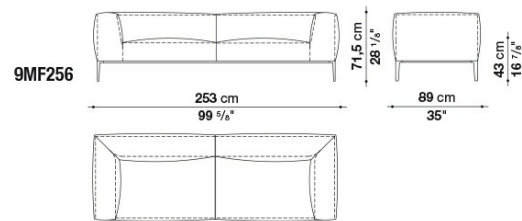

9MF256

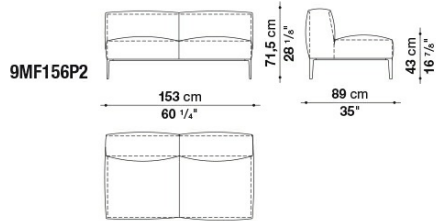

9MF156P2

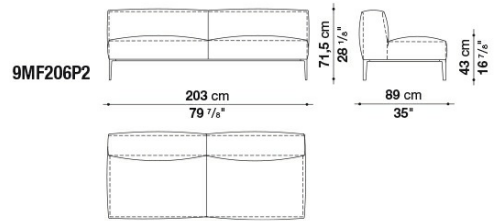

9MF206P2

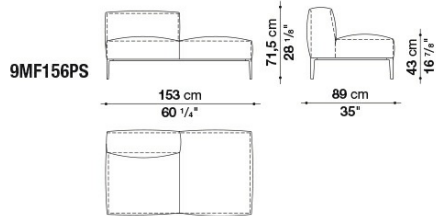

9MF156PS

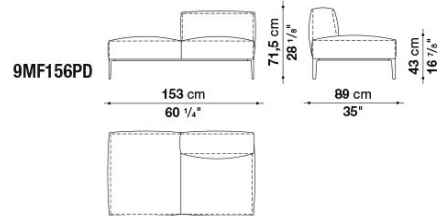

9MF156PD

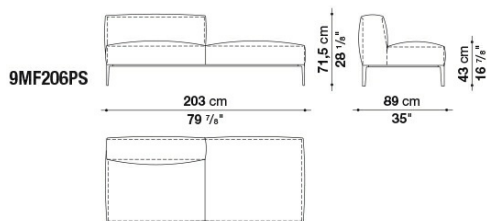

9MF206PS

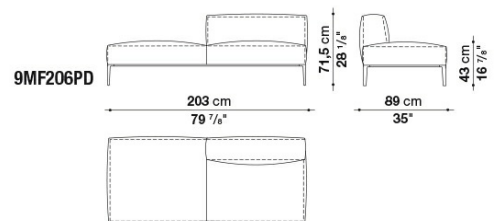

9MF206PD

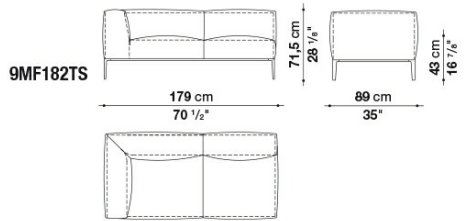

9MF182TS

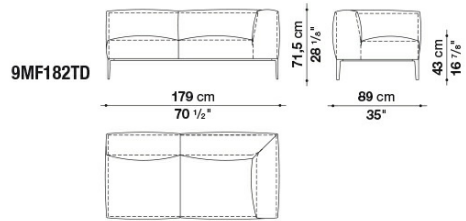

9MF182TD

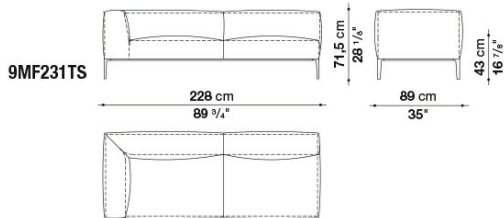

9MF231TS

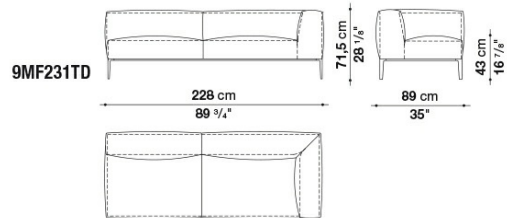

9MF231TD

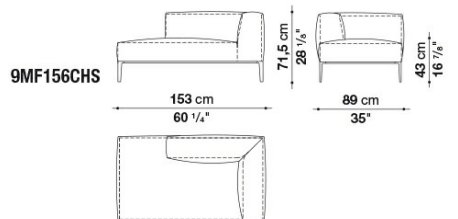

9MF156CHS

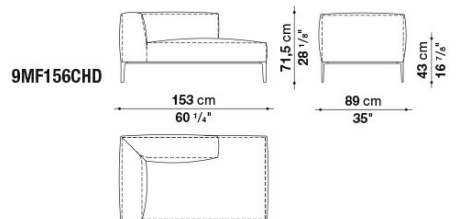

9MF156CHD

9MF231CHS

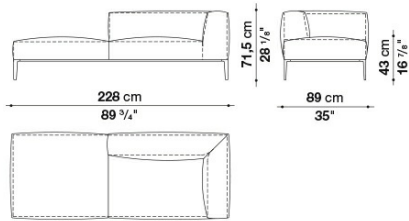

9MF231CHS

9MF231CHD

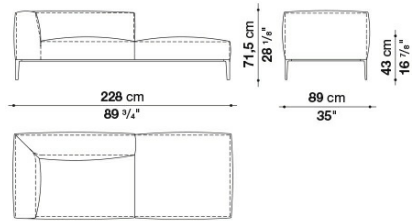

9MF231CHD

9MF91PQ

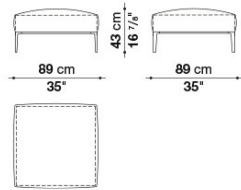

9MF91PQ

9MF156P

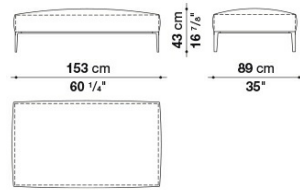

9MF156P

MF206

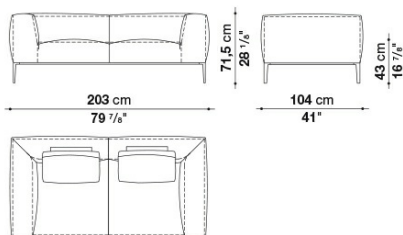

MF206

MF226\_1

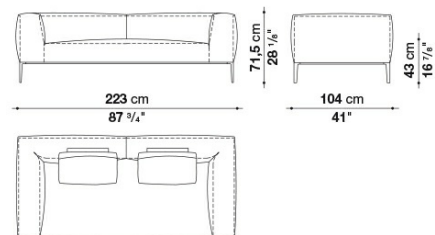

MF226\_1

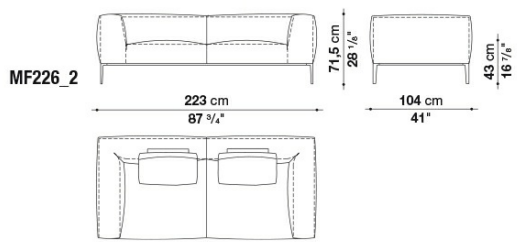

MF226\_2

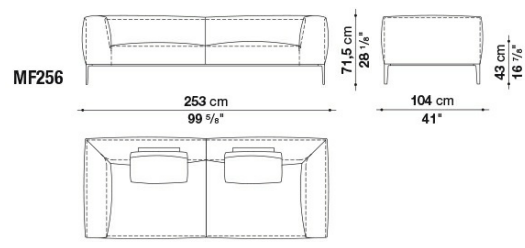

MF256

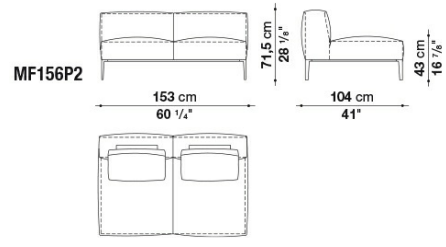

MF156P2

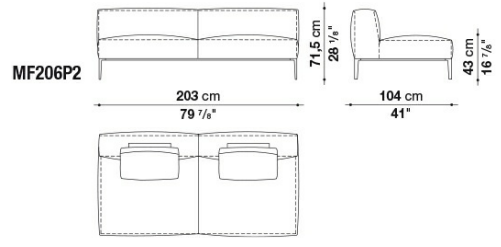

MF206P2

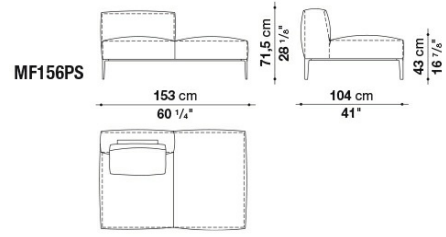

MF156PS

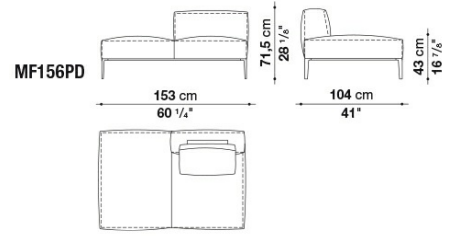

MF156PD

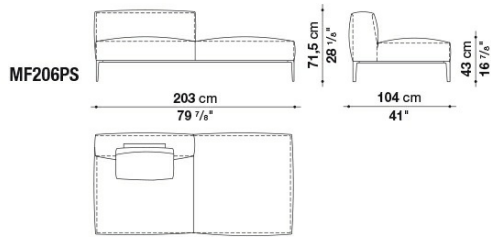

MF206PS

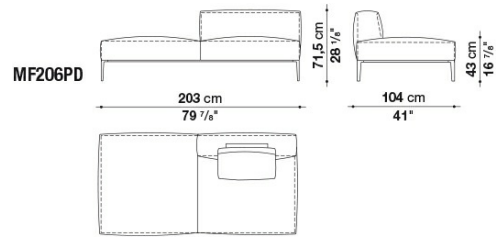

MF206PD

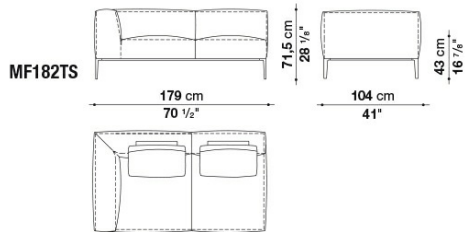

MF182TS

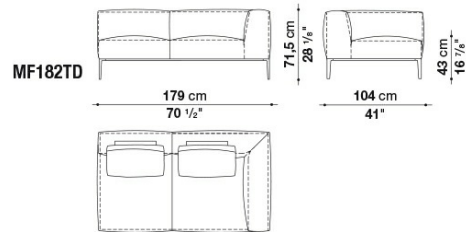

MF182TD

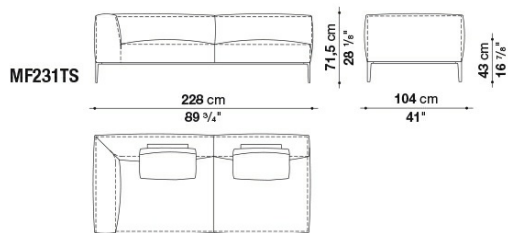

MF231TS

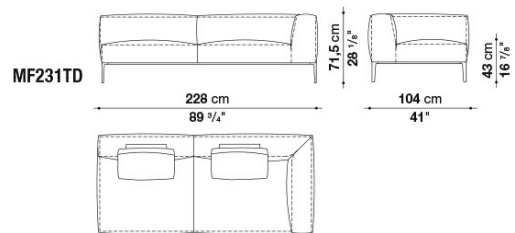

MF231TD



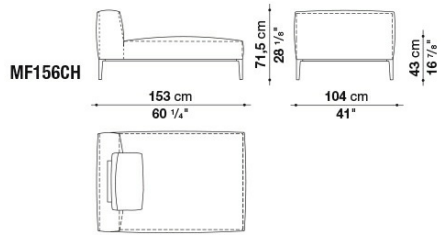

MF156CH

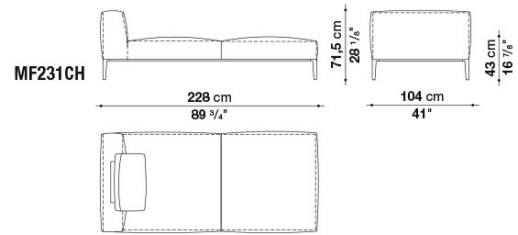

MF231CH

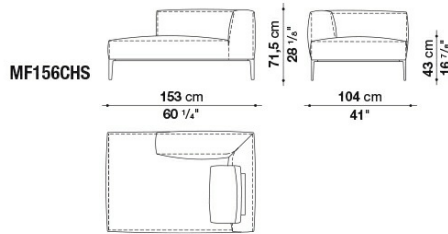

MF156CHS

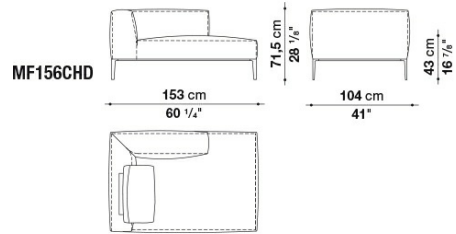

MF156CHD

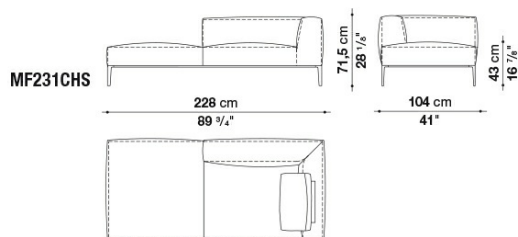

MF231CHS

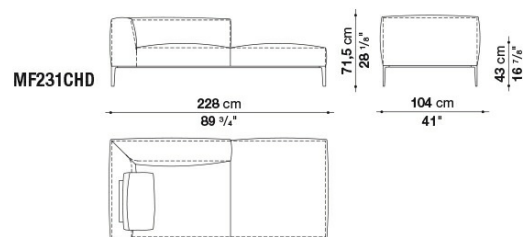

MF231CHD

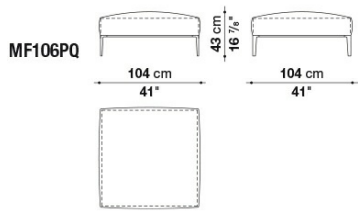

MF106PQ

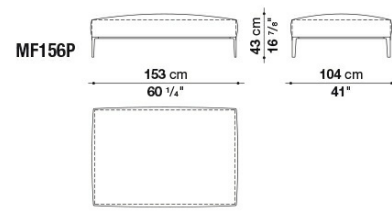

MF156P

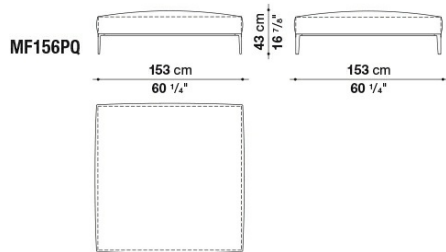

MF156PQ

---

# Compositions

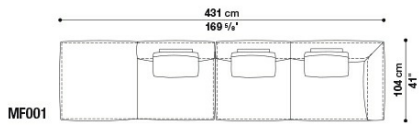

01

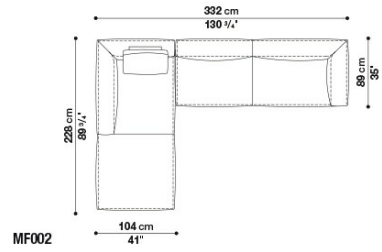

02

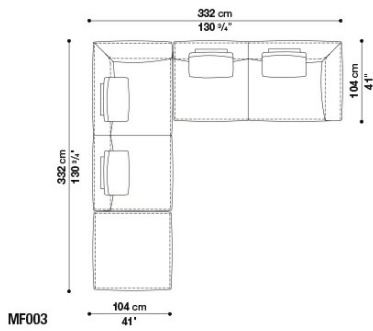

03

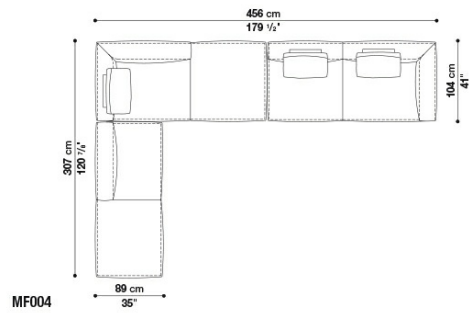

04

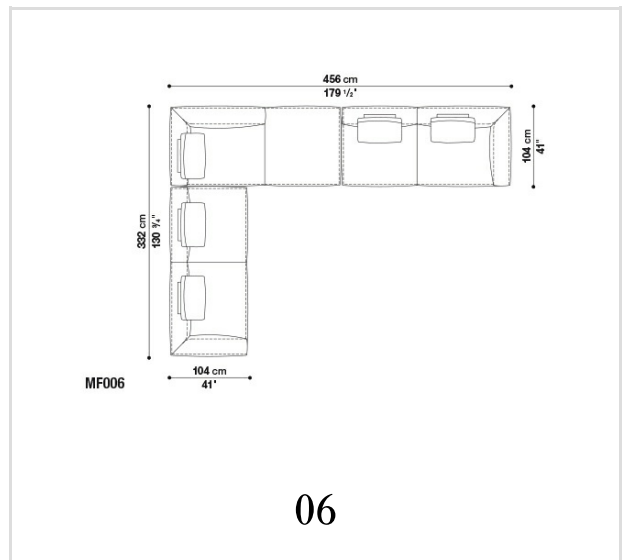
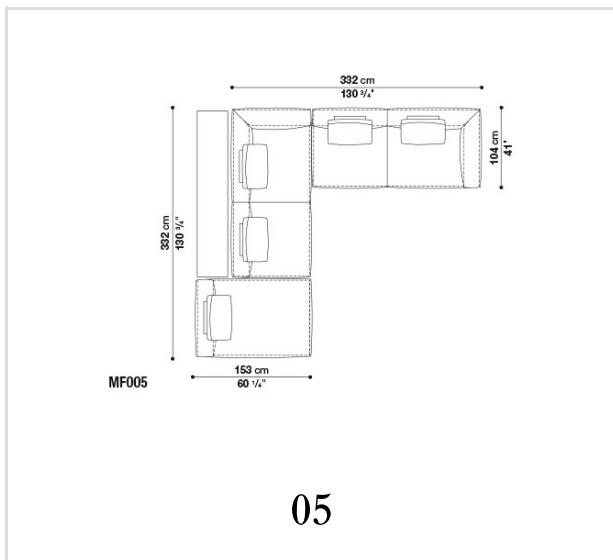

B&B Italia reserves the right to make technological and aesthetic improvements to its models, including changes to the sizes and materials, without notice. The technical drawings do not define the details of the product. The measurements shown are indicative and may undergo changes. In particular, the dimensions relevant to the padded parts are subject to usage tolerances over time caused by the normal adjustment of the padding. For the specific information, please contact the dealer closest to you.